

SWEETLIFT 2.0
TECHNICO COMMERCIAL



SweetLiFT

VOTRE ASCENSEUR PRIVATIF
YOUR HOMELIFT



Un vrai sans local de machinerie A real machine room-less

SweetLIFT s'est donné comme objectif dès le début de sa conception, de ne rien avoir à l'extérieur de la gaine ou du pylône. Par conséquent tout le matériel mécanique ou électrique est totalement intégré.

SweetLIFT Has been designed to have nothing outside of the shaft or structure. Therefore all mechanical and electrical equipment is fully integrated

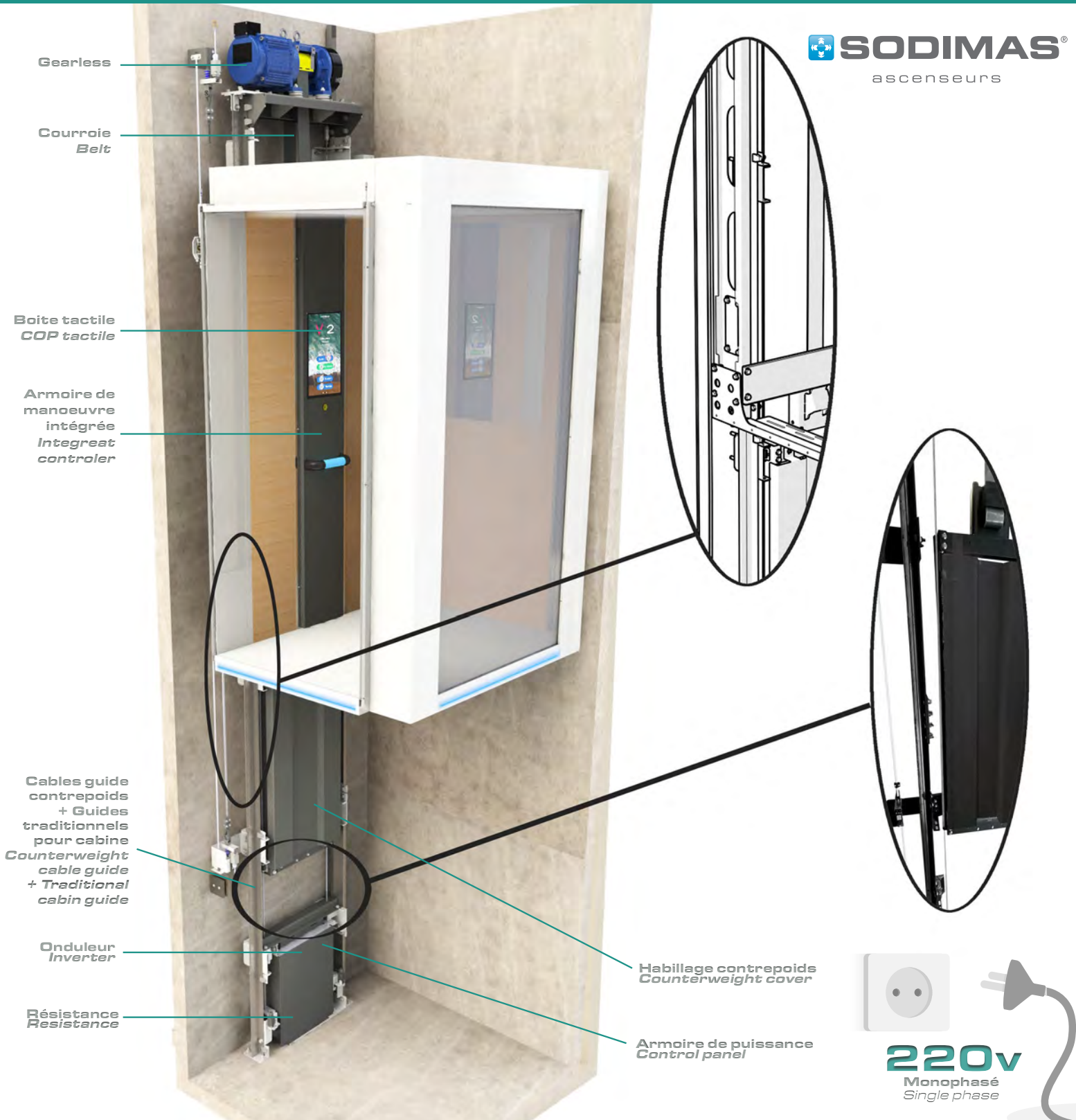

Une conception simple et technologique A simple but technological design

Notre SweetLIFT est le fruit de plusieurs années de développement. Nos ingénieurs ont repris la conception d'un ascenseur standard pour l'adapter à vos foyers, faisant de SweetLIFT l'ascenseur pour particulier le moins bruyant et le plus sécuritaire.

Our engineers have carried over the design of a standard elevator and adapted it for your home, making SweetLIFT the smoothest and safest personal elevator on the market.

Un déplacement en toute confiance *Travel with confidence*

En cas de coupure de courant, la cabine sera ramenée automatiquement au niveau le plus proche et ouvrira ses portes pour permettre aux usagers de sortir librement sans attendre l'intervention d'une personne extérieure.

In the event of a power failure, the lift automatically travels to the nearest level and opens its door to allow users to exit freely without waiting for the intervention of an engineer.

A**GEARLESS**

Une consommation énergétique optimisée *Optimized energy consumption*

L'utilisation d'une machine gearless électrique de 1.3Kw, d'une masse d'équilibrage et d'une mise en veille automatique des éléments électroniques, garantissent une consommation électrique nettement en dessous des standards du marché ainsi qu'un faible niveau sonore en fonctionnement grâce à son entraînement par courroie.

The use of a 1.3Kw electric gearless machine, a counterweight and an automatic standby for electronic elements, guarantees a power consumption well below market standards as well as a low noise level during operation thanks to its belt drive technology.

0.40m/s

0.15 m/s en union européenne
0.15 m/s in EU countries

6 personnes maximum *6 passengers maximum*

**Conforme à la réglementation Européenne Directive Machines 2006/42/CE.
Certificat d'examen CE délivré par la société APAVE qui valide l'ensemble de la conception.
Complies with European Machinery Directive 2006/42/EC.
CE examination certificate issued by the APAVE company which validates the entire design.**



**TVA réduite à 5.5%
Crédit d'impôts de 25%
Uniquement en France**



SweetLIFT

SweetLIFT est 100% conçu et fabriqué en France
(appareil certifié CE),

Nos ingénieurs ont conçu SweetLIFT afin de pouvoir
l'installer dans une cuvette réduite à 100mm et une hauteur
dernier niveau à seulement 2500mm.

*SweetLIFT is 100% designed and manufactured in France
(CE certified device),*

*Our engineers designed SweetLIFT to be able to
install it in a bowl reduced to 100mm and a top level height of
only 2500mm.*

**La mobilité réduite est cœur de nos
préoccupations, mais sans compromis
sur l'esthétique !**

***Mobility at the heart of our concerns, but
without compromising on aesthetics !***

SweetLIFT améliore le confort de vie et permet le
transport de personne en fauteuil roulant, grâce aux
dimensions de sa cabine et à ses portes automatiques

*SweetLIFT improves living comfort and allows the
transport of people in wheelchairs, thanks to the
dimensions of its cabin and its automatic doors*

Panneau de commande
Car operating panel

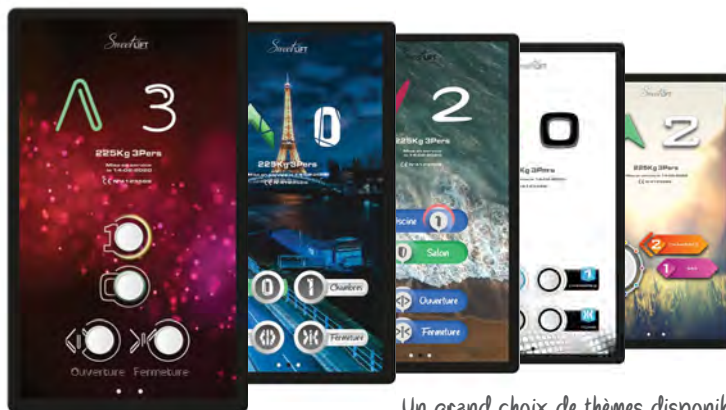
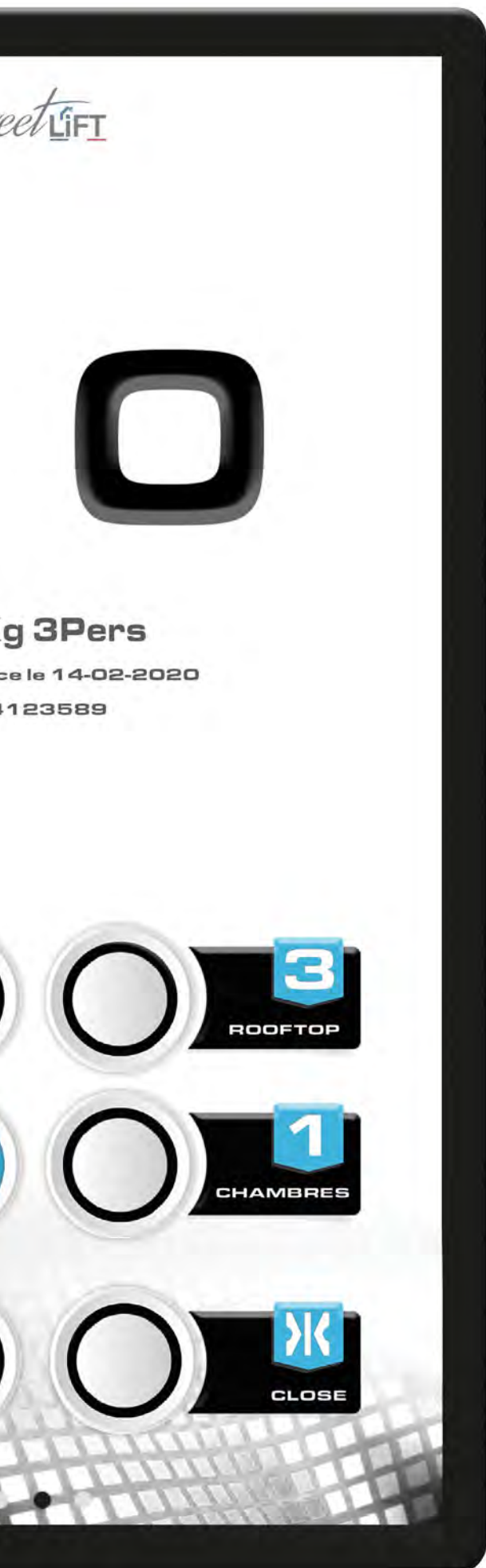

Un grand choix de thèmes disponibles
A large choice of themes available

Une boîte à boutons tactile !
Touch screen control panel !

SweetLIFT intègre une boîte à boutons 100% tactile de 15". Grâce à son grand nombre de couleurs et sa réactivité, vous découvrirez une utilisation des plus intuitive.

Sa connexion internet vous permettra d'afficher un contenu interactif comme la météo en direct.

Conçue avant tout pour les utilisateurs, elle vous offrira un grand choix de thèmes pré enregistrés ainsi qu'un grand nombre de playlists musicales. Egalement conçue pour les ascensoristes, elle vous permettra d'accéder directement au réglage de l'appareil via sa Qi touch intégrée.

SweetLIFT vous offre également la possibilité de lier cette boîte à boutons tactile avec des boutons mécaniques ou bien un clavier numérique conforme à la norme handicap.

SweetLIFT integrates a 15" touch screen panel. Thanks to its large number of colours and its reactivity, you will find it very user friendly. Designed for the user, it will offer you a large choice of pre-recorded themes as well as a large number of music playlists. Also designed for lift technicians, it will allow you to directly access the device settings via its integrated Qi touch control panel. Finally, its internet connection will allow you to display interactive content such as live weather, streaming news etc

As an optional extra the SweetLIFT also offers you the possibility of linking this touchscreen control panel with optional mechanical buttons or a numeric keyboard conforming to disabled standards.



Un large choix de playlists musicales
A large choice of music playlists



Une météo en temps réel
Real-time weather

**Traction par courroie !
Belt traction !**

L'entraînement de SweetLIFT se fait uniquement via une courroie hautement résistance (traction 1/1), composée de 31 câbles acier enrobés d'une gaine polyuréthane.

SweetLIFT is driven solely via a high-strength belt (1/1 traction), made up of 31 steel cables coated in a polyurethane sheath.

*1 seul mur de soutien suffit !
1 support wall is enough !*

**Un confort acoustique reconnu
Engineered for minimum noise.**

SweetLIFT bénéficie d'un traitement acoustique particulier. La position du moteur en haut de gaine, associé à une conception novatrice, en font un produit silencieux.

SweetLIFT benefits from special acoustic treatment. The position of the motor at the top of the shaft, combined with an innovative design, makes it a silent product.



Sweet **LIFT**

**Un guidage cabine classique et un guidage
contrepois innovant !
Classic cabin guidance and innovative
counterweight guidance !**

SweetLIFT est équipé de guides traditionnels pour sa cabine et innove en guidant son contrepois avec des câbles. Cela permet un déplacement très confortable. Il offre également un temps de montage réduit.

SweetLIFT is equipped with traditional guides for its cabin and innovates by guiding its counterweight with cables. This allows for very comfortable travel. It also offers reduced assembly time.



**Départ de guide et
Armoire de puissance
pivotante en cuvette**
**Departure of guide and
Controler swivel in bowl**

- Butée
Safety butters
- Résistance
Resistance
- Arrivée puissance
Power connections
- Variateur de fréquence
Frequency converter
- Contôle de la tension
des câbles guide
Checking guide cable
tension
- Onduleur
UPS battery back up

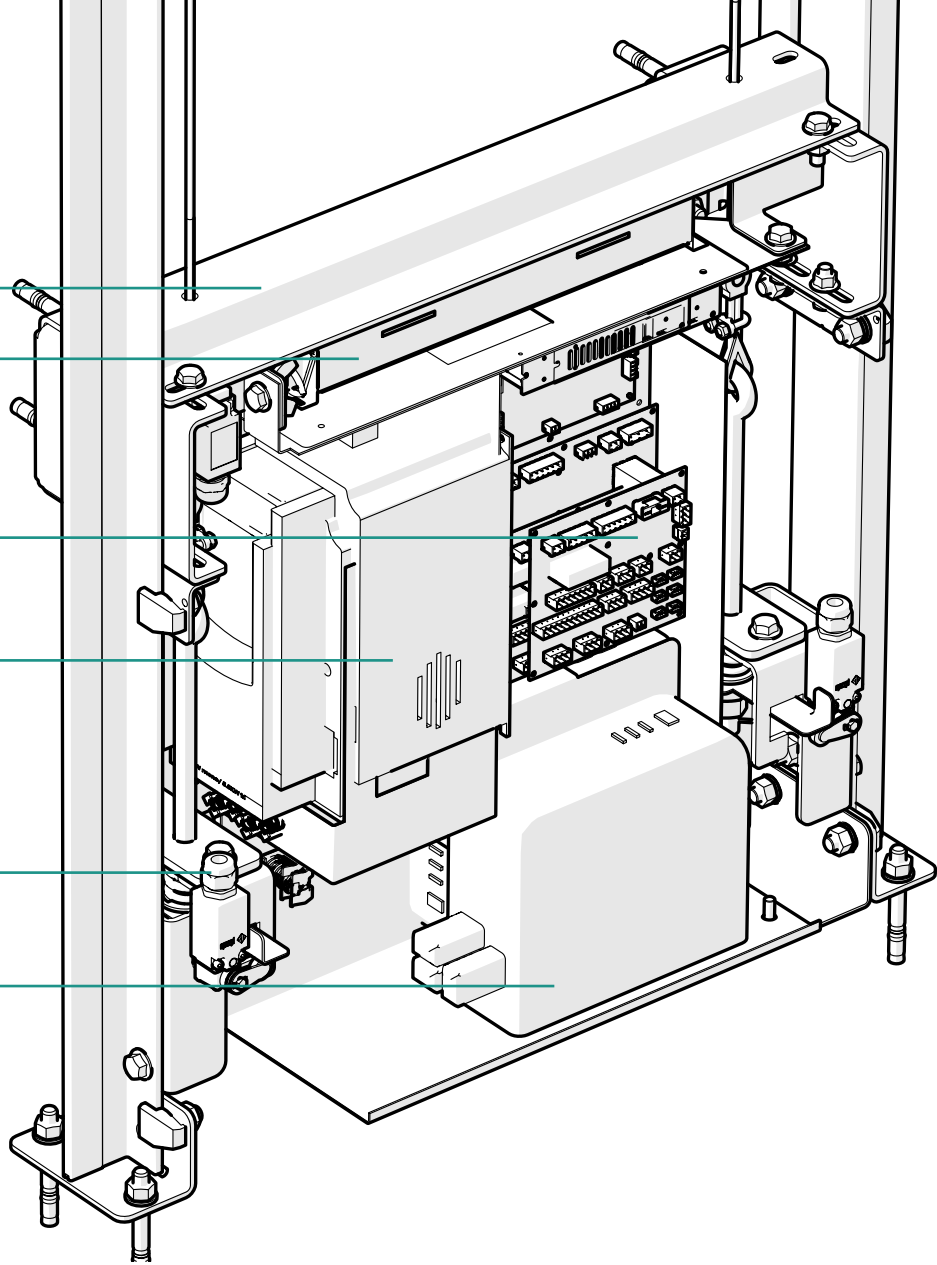

 **SODIMAS**[®]
ascenseurs

*Gain de temps et de poids !
Save time and weight !*



Pré-montés en usine
Pre-assembled in the factory

SweetLIFT est conçu pour un assemblage simple, c'est pourquoi nos modules arrivent précablés, assemblés et directement synchronisés (Gearless / Armoire / Boite à boutons) en usine prêt à être posés.

Our SweetLIFT is designed for easy assembly, which is why our modules arrive pre-wired, assembled and quality checked (Gearless machine / Controller / Car operating panel) at the factory ready to be installed.

Sweet **LIFT**



Mains courantes Handrail

Tube aluminium
Aluminium tube

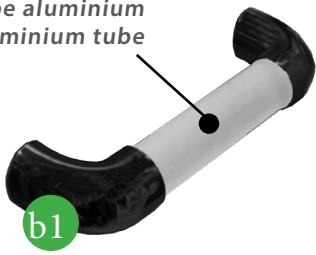

b1

Embouts noir epoxy
Black paint end caps

Tube lumineux
Luminous tube

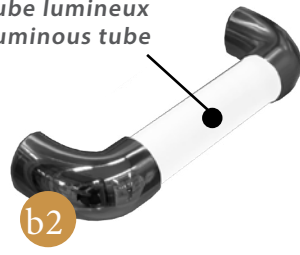

b2

Embouts noir epoxy
Black paint end caps

Tube lumineux
Luminous tube

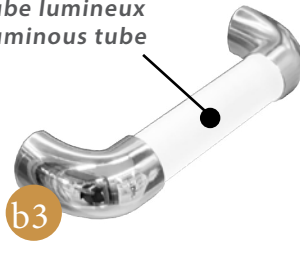

b3

Embouts chromés
Chromed end caps

Tube lumineux
Luminous tube

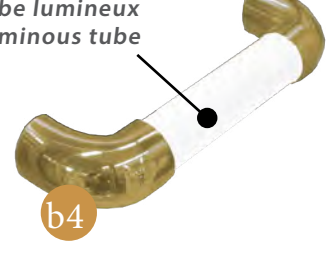

b4

Embouts Or brillant
Golden mirror end caps



Eclairage cabine Lighting car

c1 **Miroir cabine**
Car mirror



800x450mm

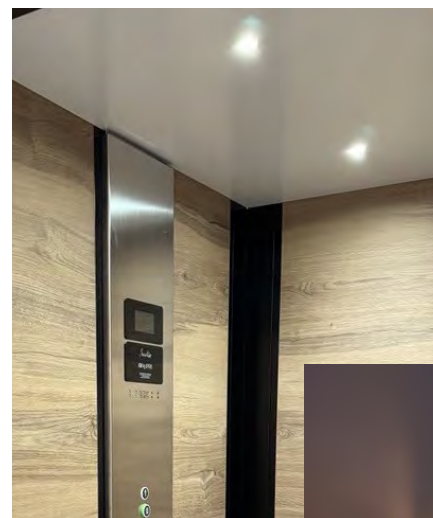

q1 **Spot à led**
LED spotlight

q2 **Périphérique**
multicolore
Multicolor device

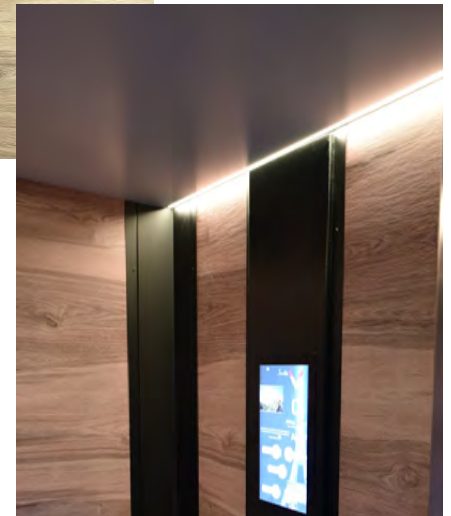

d1 **Vitrage cabine**
Car glass

Disponible sur toutes les faces
Available on all sides

Verre feuilleté clair
Épaisseur 44/2 (8mm)
Clear laminated glass
Thickness 44/2 (8mm)



**Plafond cabine
Car ceiling**



Blanc / White

e1



Noir / Black

e2



RAL au choix
RAL of your choice

e3

**Parois cabine mélamine (de base)
Car melamine finishes (basic)**



f1



Rovere Dallas
14Y Blues

f2



Pino Valkiria
11Y R&R

f3



Rovere Niagara
64U R&R

f4



Rovere Chicago
62U Blues

**Parois cabine ARPA
Car ARPA finishes**

g1



669

g2



0509

g3



850

g4

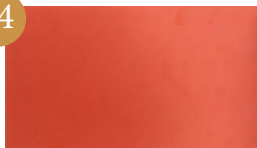

432

g5



1908

g6



4605

g7



1909

g8



D10A

g9



K003

g10



634

g11



M132

g12



V106

g13



3408

g14



4514

g15

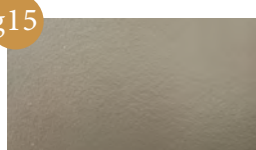

0623

g16



4516

g17



4532

g18



4603

g19



4602

h1

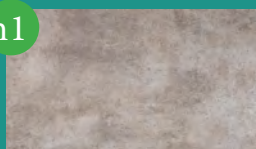

Leone clear
2064

h2

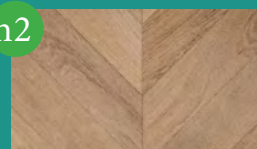

Azay cream
2346

h3



Leone anthracite
2133

h4



Gris stone
Square

**Sols cabine
Car floor
choices**

h7



Tarabus

h8

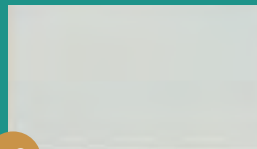

Décaissé / Disburse
15mm max

Commande et signalisation cabine Car operating panel



Inox brossé
Brushed stainless steel



Inox lino
Linen stainless steel



Inox gravé
Engraved stainless steel



Inox Or brillant
Golden mirror stainless steel



RAL au choix
RAL of your choice
RAL 9005 de base
Prélaqué lisse
RAL 9005 base
Pre-painted smooth

Profil d'habillage intérieur cabine Car interior trim profiles

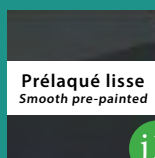

Prélaqué lisse
Smooth pre-painted
RAL 9005 de base
RAL 9005 base

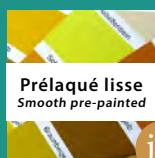

Prélaqué lisse
Smooth pre-painted
RAL au choix
RAL of your choice

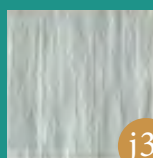

Inox brossé
Brushed stainless steel

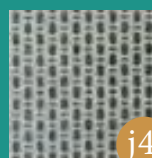

Inox lino
Linen stainless steel



Inox Or brillant
Golden mirror stainless steel

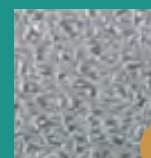

Inox gravé
Engraved stainless steel

Portes palières battantes
Landing swing door swing

Ouverture à droite et à gauche / PL 600 -> 900 mm
Right or left opening / 600 -> 900 mm CO

Disponible en version
MOTORIZÉE
Fully MOTORIZED
and HIDDEN

k7

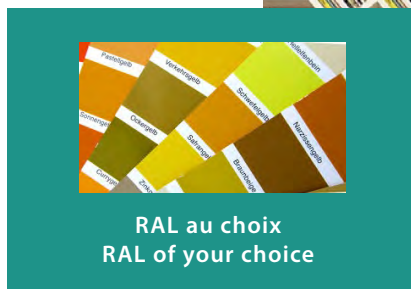

CLEA "K1" non inclu
CLEA "K1" not included



MyPAL

Portes automatiques ouverture latérale SD20
2 vantaux avec porte cabine
SD20 side opening automatic doors
2 leaves with door cabin

- 11 **Sans façade**
Without facade
- 12 **Avec façade**
With facade

Ouverture à droite et à gauche / PL 700 -> 900 mm
Right or left opening / 700 -> 900 mm

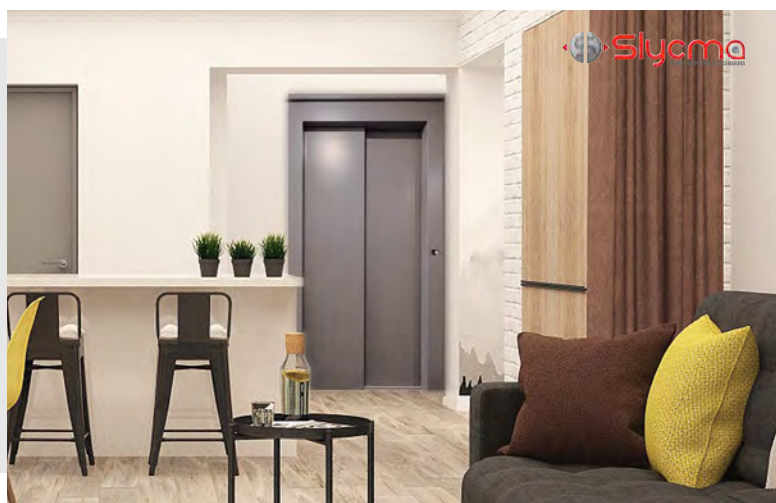

* Calfeutrement de la même teinte - Caulking of the same color

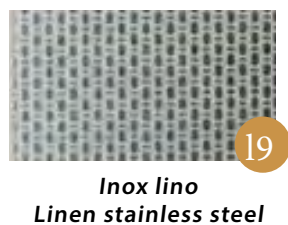

Pylône Structure

SweetLiFT vous offre la possibilité de personnaliser totalement votre pylône, vous avez ainsi la possibilité de choisir sa finition parmi une palette de RAL fournis. Vous pouvez également choisir en fonction de votre domicile et de son emplacement des faces vitrées, tôlees ou habillées de nos panneaux Déco réalisés sur mesure en fonction de vos attentes (montage depuis l'intérieur pylône).

SweetLiFT offers you the possibility of completely customizing your structure, so you can choose its finish from a range of RAL colours supplied. Depending on your home and its location, you can choose clear or patterned glass, or our decorative panels which are designed according to your requirements. (assembly from inside pylon).



m1 Tous les RAL sont disponibles
Full RAL color range available

Un pylône aluminium 100% Sodimas A 100% Sodimas aluminium structure

Montage Intérieur ou
extérieur du bâtiment
non autoportant
Indoor mounting or
building exterior
not self-supporting



m2 **Blanc A3000** de base mat texturé fine
Intérieur et extérieur au choix

White A3000 basic matt fine textured
Interior and exterior to choose from



Capotage toit
cabine
Hood car

Capotage
montants cabine
Hood profile car

Capotage plancher
cabine
Hood under car



Capotage extérieur cabine (toit, montants et plancher)
Exterior car trim profiles (Exterior roof covering, uprights and floor)



n1

Inox brossé
Brushed stainless steel



n2

RAL au choix
RAL of your choice



n3

Inox lino
Linen stainless steel



n5

Inox gravé
Engraved stainless steel

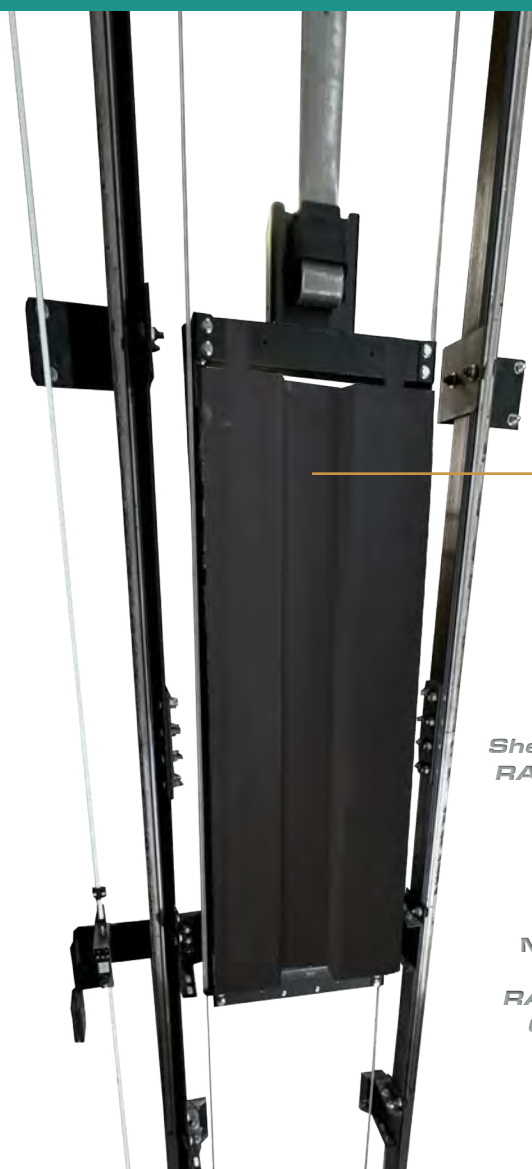

o1

Capotage
contrepois
RAL 9005 noir
Hood counterweight Black RAL 9005

Habillage tôle
RAL au choix
Sheet metal cladding RAL to choose from

p1

Habillage déco
RAL au choix
Motif sur mesure
Deco clabbing RAL to choose from Custom pattern

p2



p4

Eclairage cabine
sous plancher
Exterior car lighting

p3

Vitrage
Glazing

	Porte battante Swing door	Porte automatique SD20 SD20 automatic door
Charges Capacity	De 225kg à 400Kg From 225kg to 400Kg	
Nombre de passagers Number of passengers	De 3 à 6 personnes From 3 to 6 people	
Vitesse Speed	0.15m/s (0.40 hors EU) 0.15m/s (0.40 outside EU)	
Course maximale Maximum travel	15 mètres (minimum 1.5m) 15 meters (minimum 1.5m)	
Puissance Power	1.3Kw	
Alimentation Power supply	Monophasé 220V (7.6A max) Single phase 220V (7.6A max)	
Position de la machine Machine position	Niveau haut High level	
Hauteur minimum dernier niveau Minimum height last level	2500mm* 2500mm*	
Profondeur minimum cuvette Minimum depth	100mm*	
Passage libre Door opening widths	De 600mm à 900mm From 600mm to 900mm	De 700mm à 900mm From 700mm to 900mm
Face de service Car arrangement	Simple / double service ou service d'équerre Single / double service or square service	
Armoire Controler	Armoire Qi touch Qi touch control panel	
Nombre de démarrages par heure Number of starts per hour	60	
Manceuvre Maneuver	Blocage appel enregistré Blocking recorded call	
Pylône Pylon	Aluminium non autoportant Non self-supporting aluminum	

* Moins de 850kg (PM+CU)
* Less than 850kg (PM+UC)



Sweet **LIFT**



Élévation GAINÉ SHEATH elevation

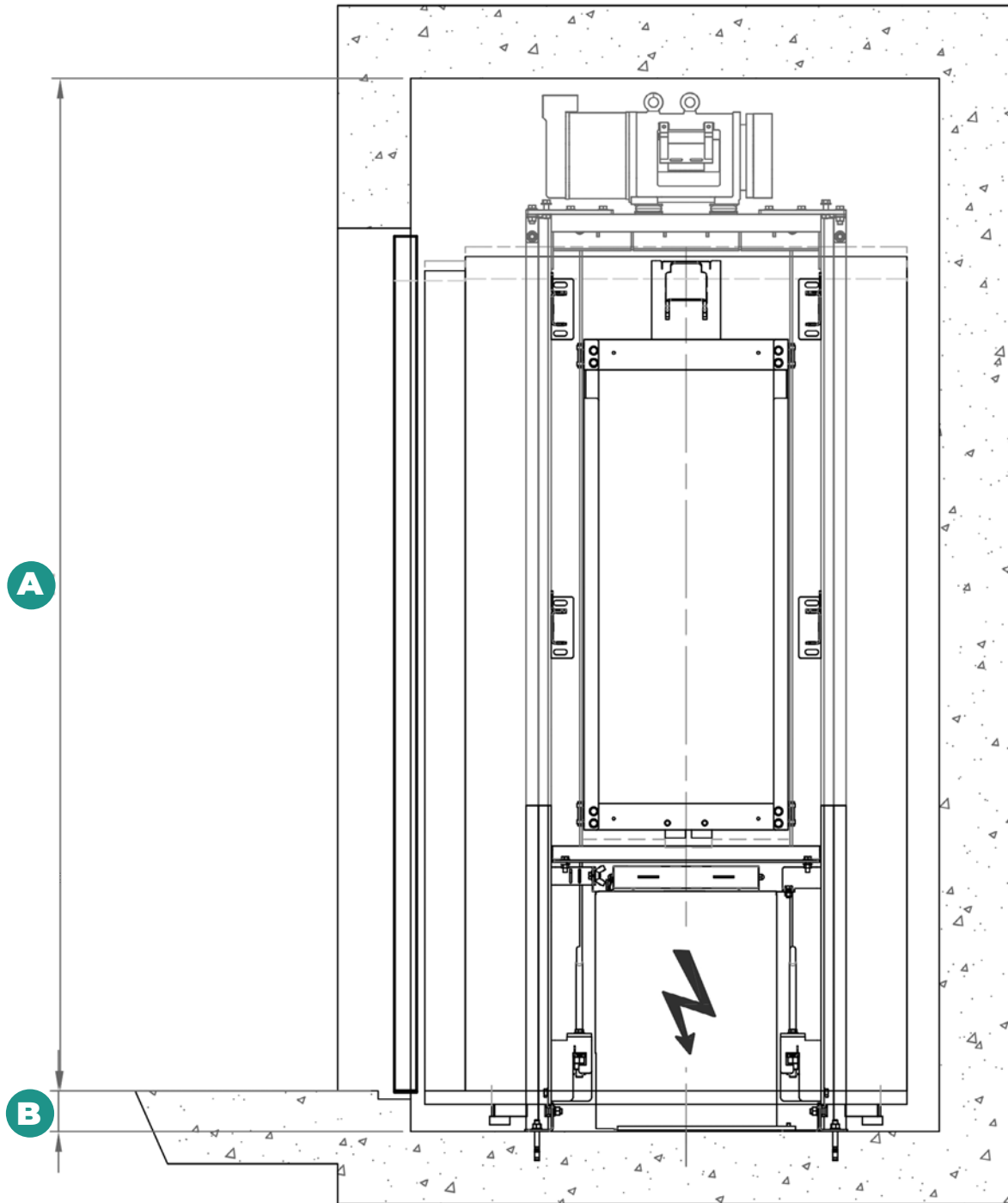

(Dimensions en mm / Size in mm)

		Battante <i>Swing door</i>	Automatique SD20 <i>SD20 automatic door</i>
Gaine / Pylône Sheath / Pylon	A	Hauteur Dernier Niveau HDN = 2500mm mini Height last level = 2500mm mini	
	B	Cuvette 100mm mini (max 500mm) / Bowl 100 mm mini (max 500mm) 110mm mni si décaissé cabine (15mm) / 110mm mini if disbursed cabin (15mm)	



Élévation PYLÔNE

PYLON elevation

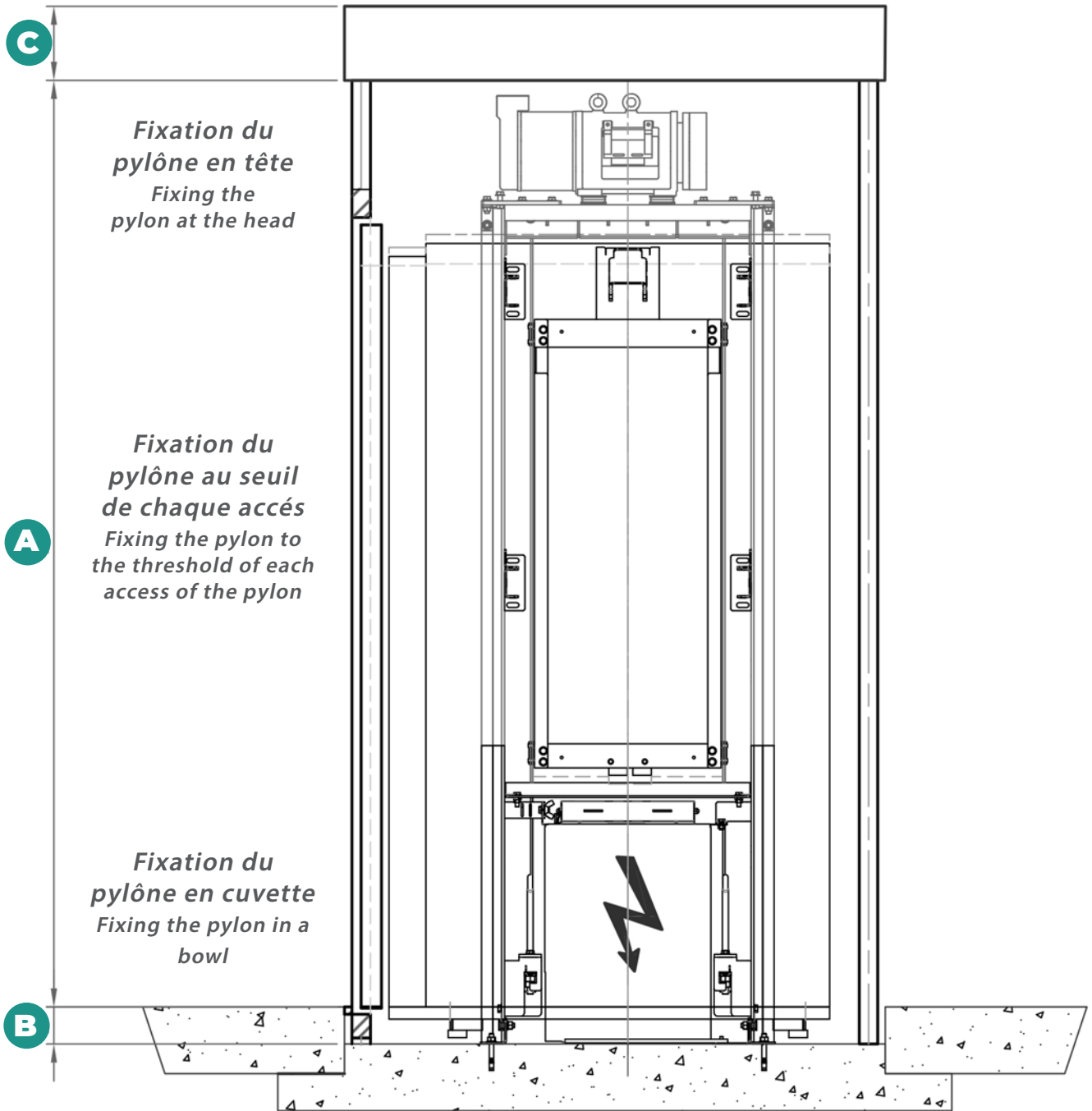

(Dimensions en mm / Size in mm)

		Battante Swing door	Automatique SD20 SD20 automatic door
Gaine Sheath	A	Hauteur Dernier Niveau HDN = 2500mm mini Height last level = 2500mm mini	
	B	Cuvette 100mm mini (max 500mm) / Bowl 100 mm mini (max 500mm) 110mm mini si décaissé cabine (15mm) / 110mm mini if disbursed cabin (15mm)	
	C	50mm min (si couverture pylône en intérieur bâtiments / if pylon coverage inside buildings) 200mm min (si couverture pylône extérieur bâtiments / if cover pylon exterior buildings)	



Solution simple accès Simple access

Mécanique en face B ou D
Mechanics in face B or D



Gaine
Sheat

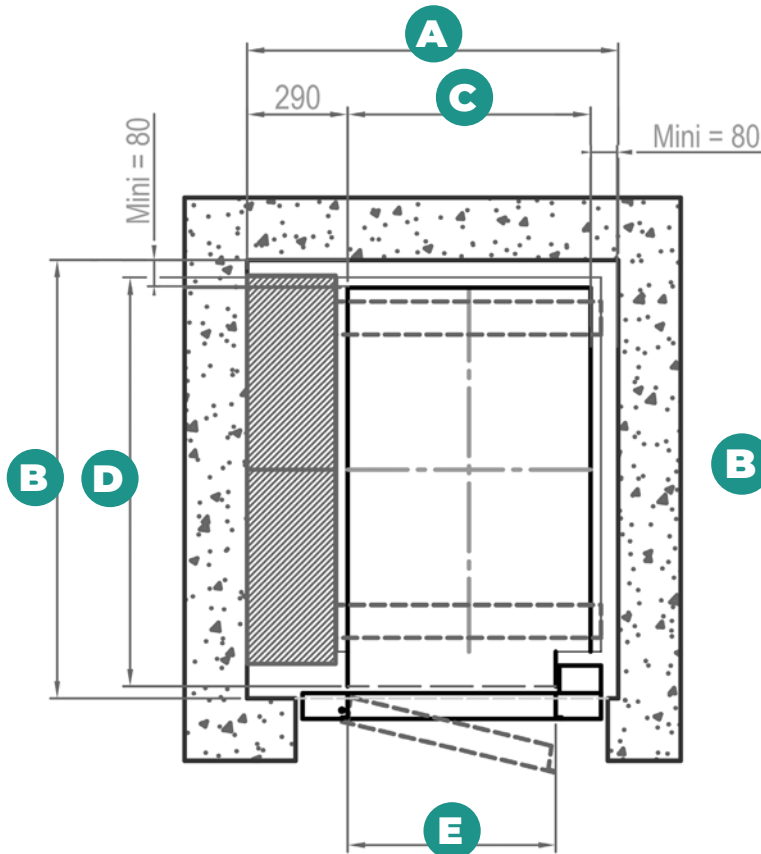

Pylône
Pylon

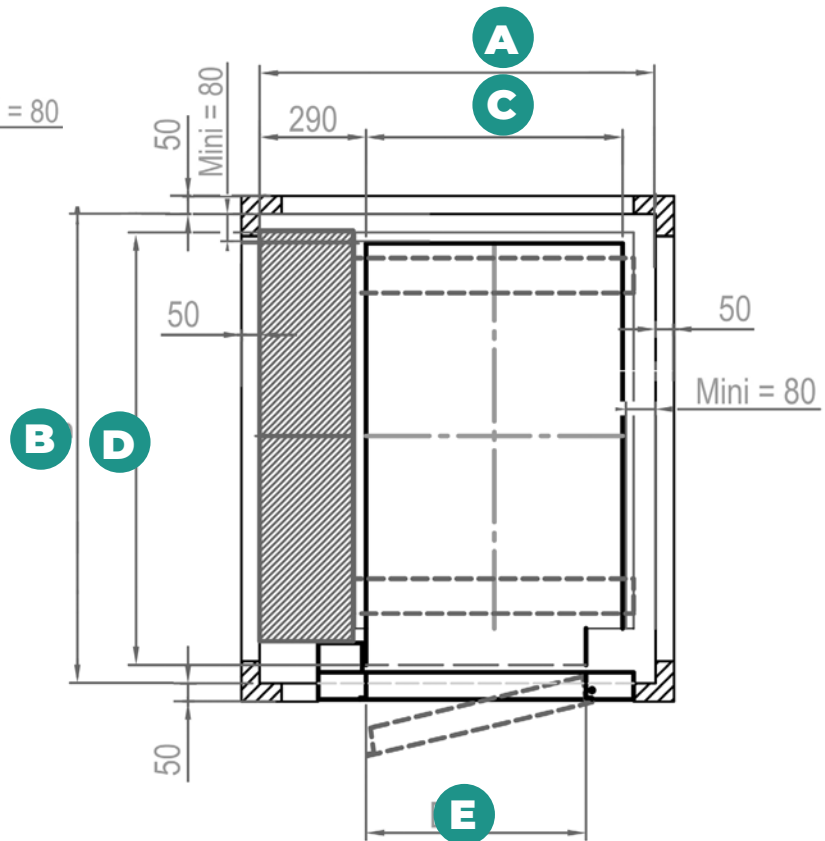

(Dimensions en mm / Size in mm)

		Gaine maçonnée Masonry sheath		Gaine Pylône Pylon Sheath	
		Mini	Maxi	Mini	Maxi
Vide libre intérieur Interior free space	A	1070	1470	1080	1470
	B	1305	1515	1320	1530
Cabine Car	C	700	1100	700	1100
	D	1190	1400	1190	1400
Passage libre Freeway	E	600	900	600	900

Porte battante / Swing door

SweetLIFT



Solution gaine simple accès Simple access

Mécanique en face C
Mechanics in face C



Gaine
Sheat

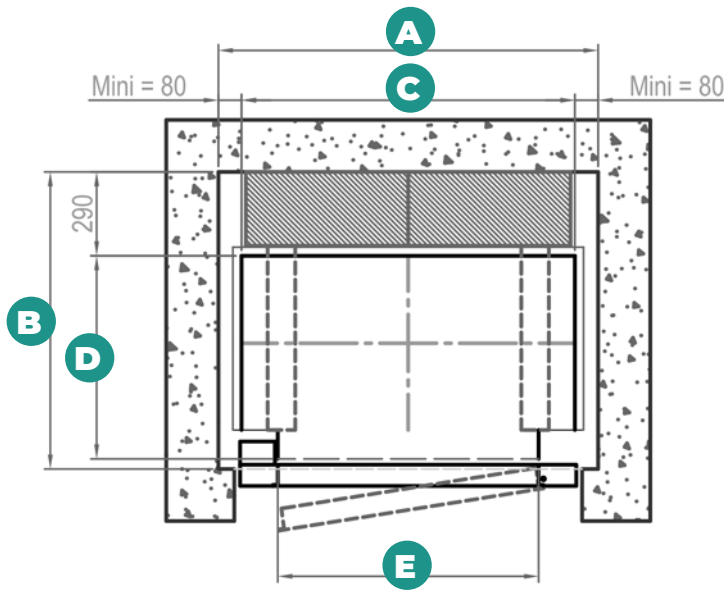

Pylône
Pylon

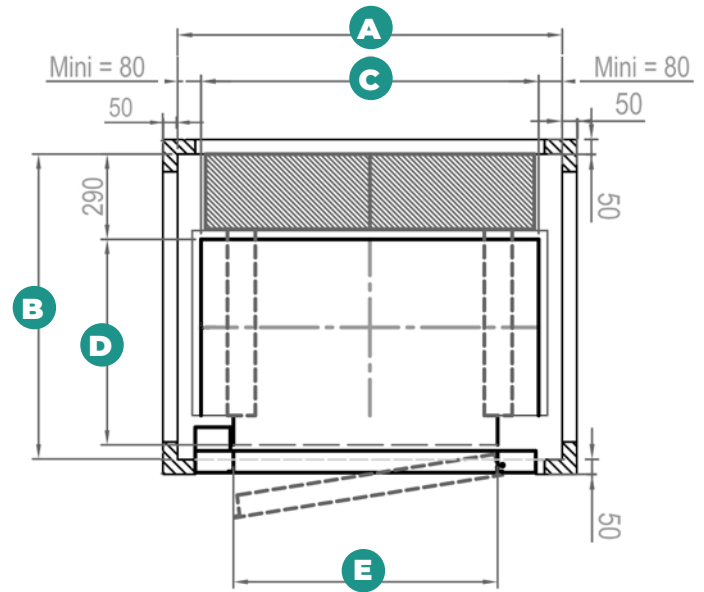

(Dimensions en mm / Size in mm)

		Gaine maçonnée Masonry sheath		Gaine Pylône Pylon Sheath	
		Mini	Maxi	Mini	Maxi
Vide libre intérieur <i>Interior free space</i>	A	1250	1560	1250	1560
	B	1125	1425	1140	1440
Cabine <i>Car</i>	C	1090	1400	1090	1400
	D	800	1100	800	1100
Passage libre <i>Freeway</i>	E	600	900	600	900



Solution gaine double accès Double access

Mécanique en face B et D
Mechanics in face B and D



Gaine
Sheat

Pylône
Pylon

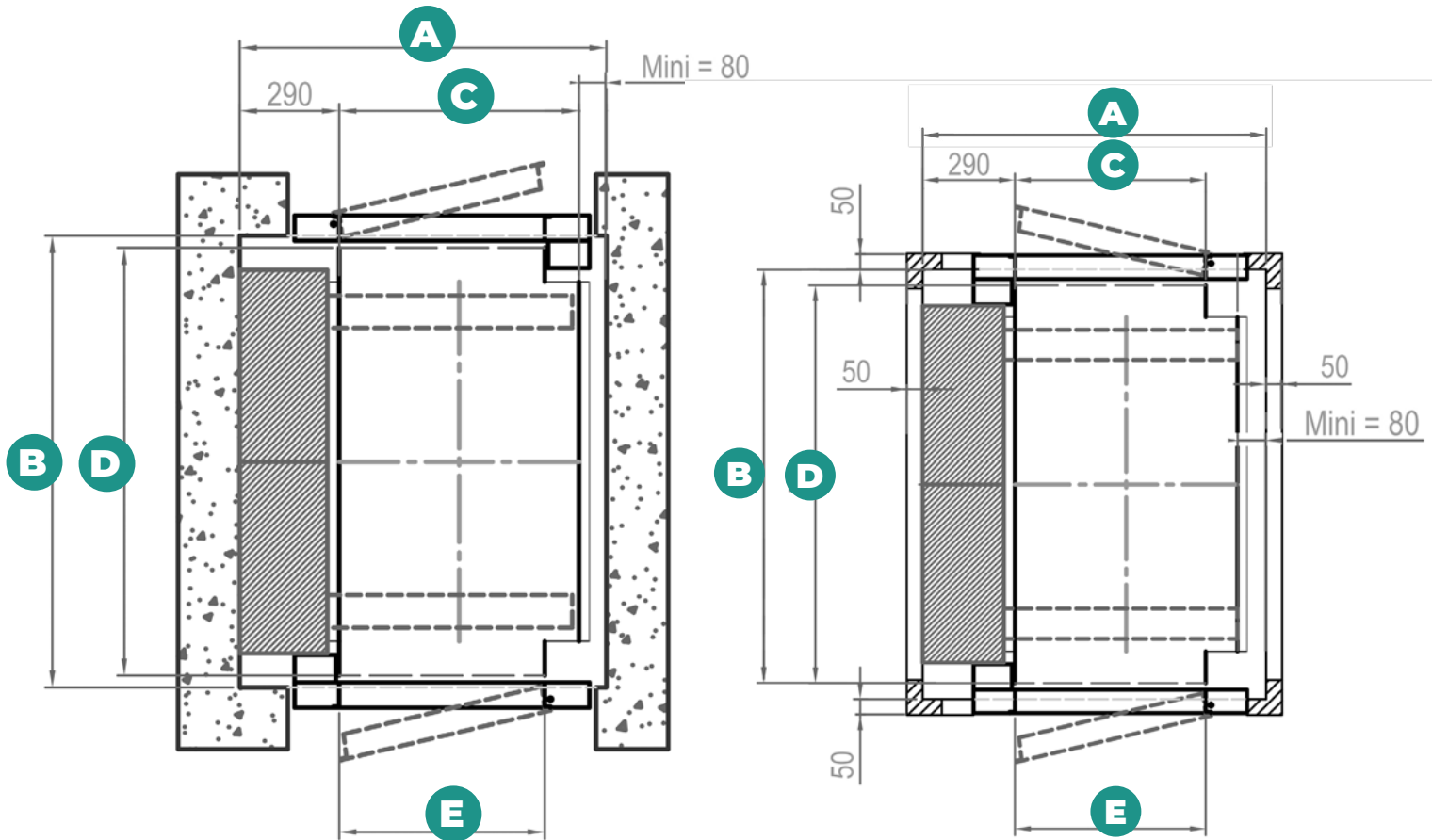

(Dimensions en mm / Size in mm)

		Gaine maçonnerie Masonry sheath		Gaine Pylône Pylon Sheath	
		Mini	Maxi	Mini	Maxi
Vide libre intérieur <i>Interior free space</i>	A	1070	1470	1080	1470
	B	1360	1470	1390	1500
Cabine <i>Car</i>	C	700	1100	700	1100
	D	1290	1400	1290	1400
Passage libre <i>Freeway</i>	E	600	900	600	900



Solution gaine service d'équerre Square service

Mécanique en face B et D
Mechanics in face B and D



Gaine
Sheath

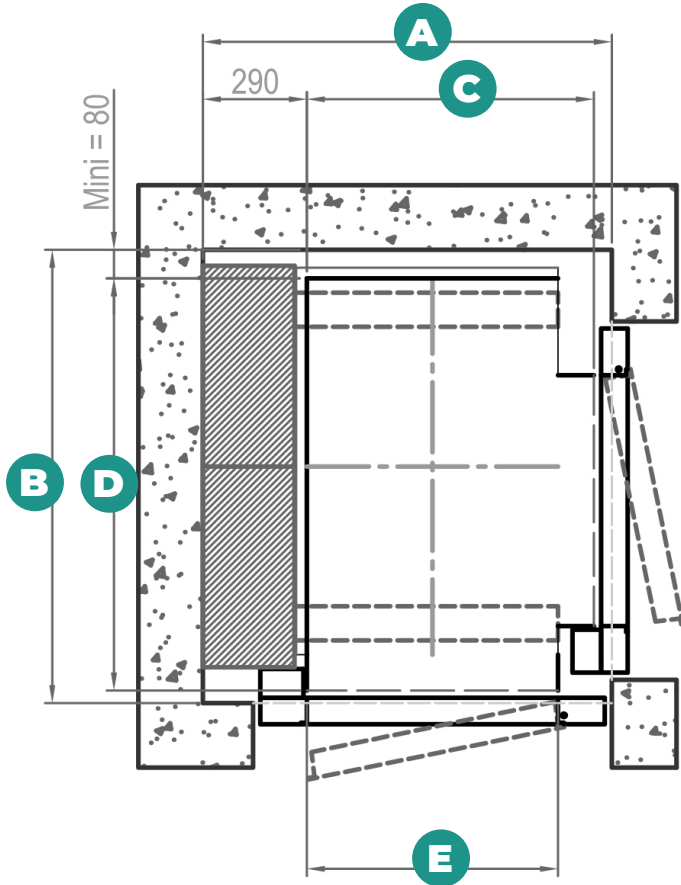

Pylône
Pylon

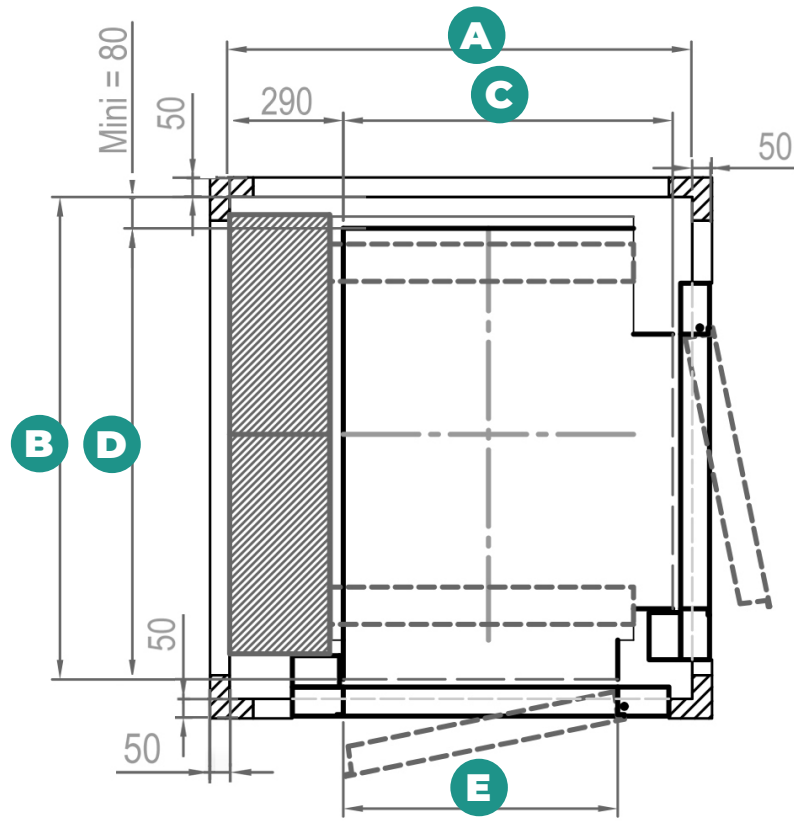

(Dimensions en mm / Size in mm)

		Gaine maçonnée Masonry sheath		Gaine Pylône Pylon Sheath	
		Mini	Maxi	Mini	Maxi
Vide libre intérieur <i>Interior free space</i>	A	1125	1425	1140	1440
	B	1305	1515	1320	1530
Cabine <i>Car</i>	C	800	1100	800	1100
	D	1190	1400	1190	1400
Passage libre <i>Freeway</i>	E	600	900	600	900



Solution gaine simple accès

Simple access

Mécanique en face B et D

Mechanics in face B and D



Gaine
Sheat

Pylône
Pylon

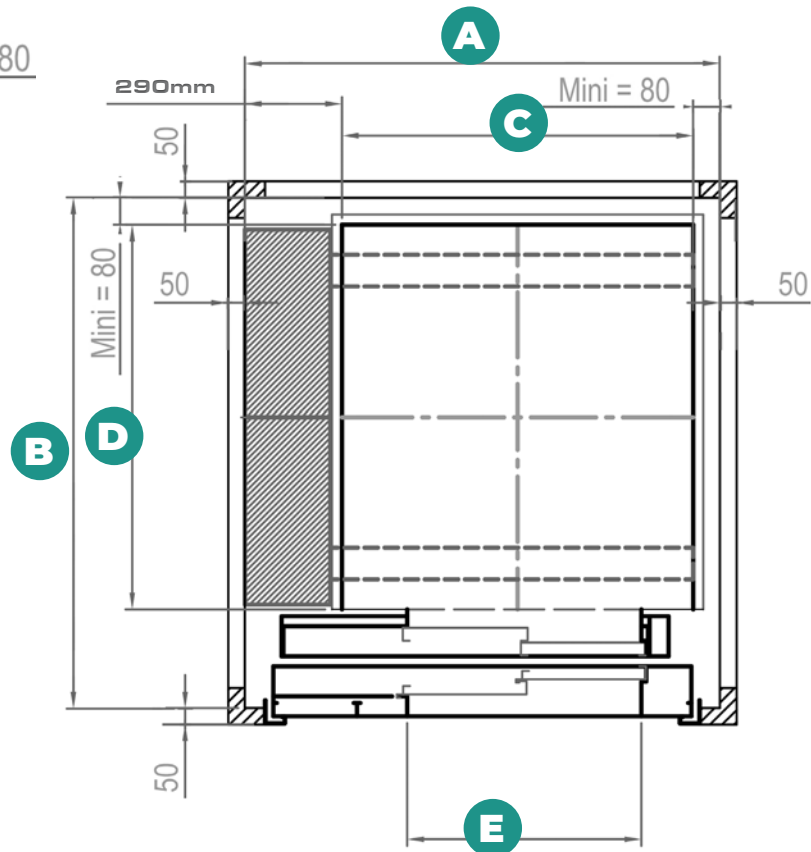
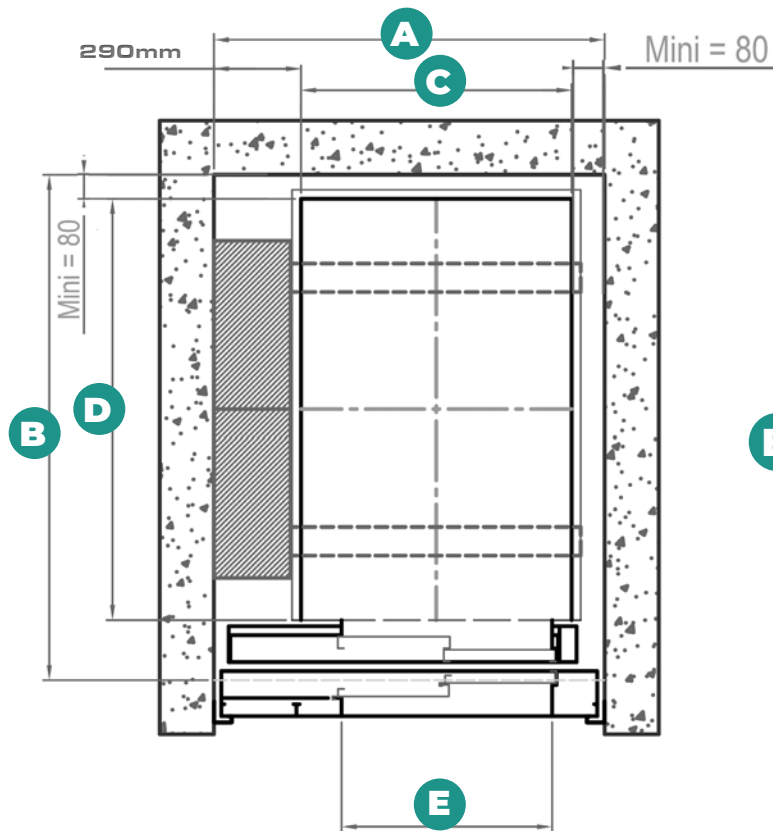

(Dimensions en mm / Size in mm)

		Gaine maçonnée Masonry sheath		Gaine Pylône Pylon Sheath	
		Mini	Maxi	Mini	Maxi
Vide libre intérieur <i>Interior free space</i>	A	1300	1600	1420	1720
	B	1430	1680	1525	1775
Cabine <i>Car</i>	C	930	1100	895	1100
	D	1150	1400	1150	1400
Passage libre <i>Freeway</i>	E	700	900	700	900



Solution gaine simple accès Simple access

Mécanique en face C
Mechanics in face C



Gaine
Sheat

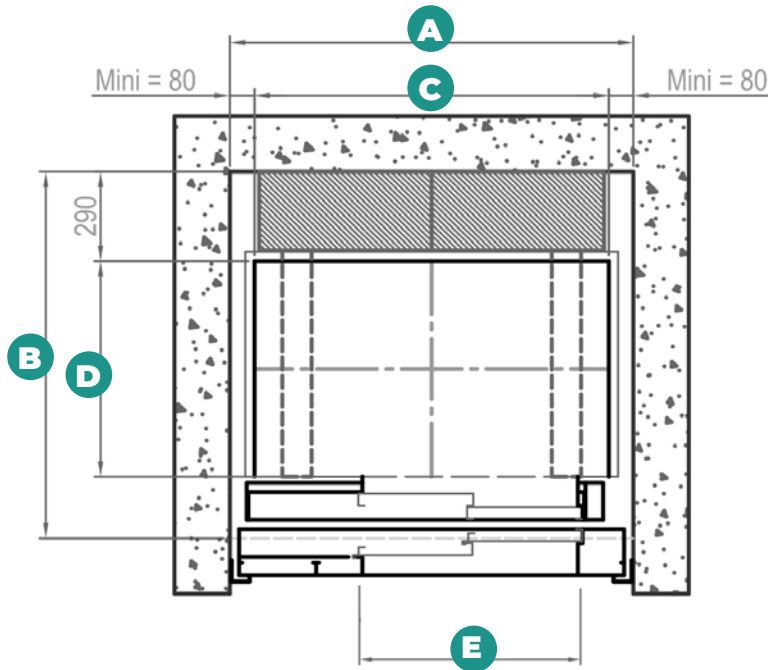

Pylône
Pylon

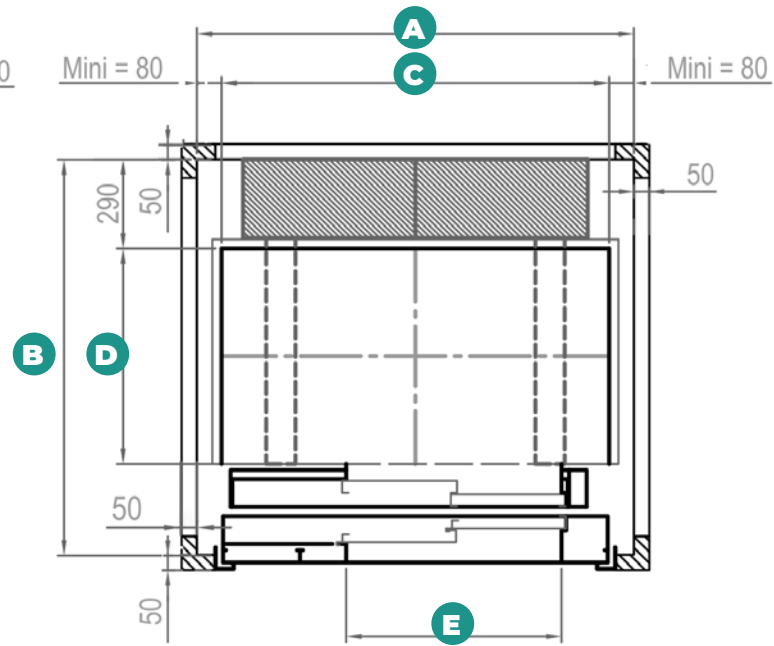

(Dimensions en mm / Size in mm)

		Gaine maçonnée Masonry sheath		Gaine Pylône Pylon Sheath	
		Mini	Maxi	Mini	Maxi
Vide libre intérieur <i>Interior free space</i>	A	1310	1600	1420	1720
	B	1190	1590	1285	1685
Cabine <i>Car</i>	C	1150	1400	1260	1400
	D	700	1100	700	1100
Passage libre <i>Freeway</i>	E	700	900	700	900



Solution gaine double accès

Double access

Mécanique en face B et D

Mechanics in face B and D



Gaine
Sheat

Pylône
Pylon

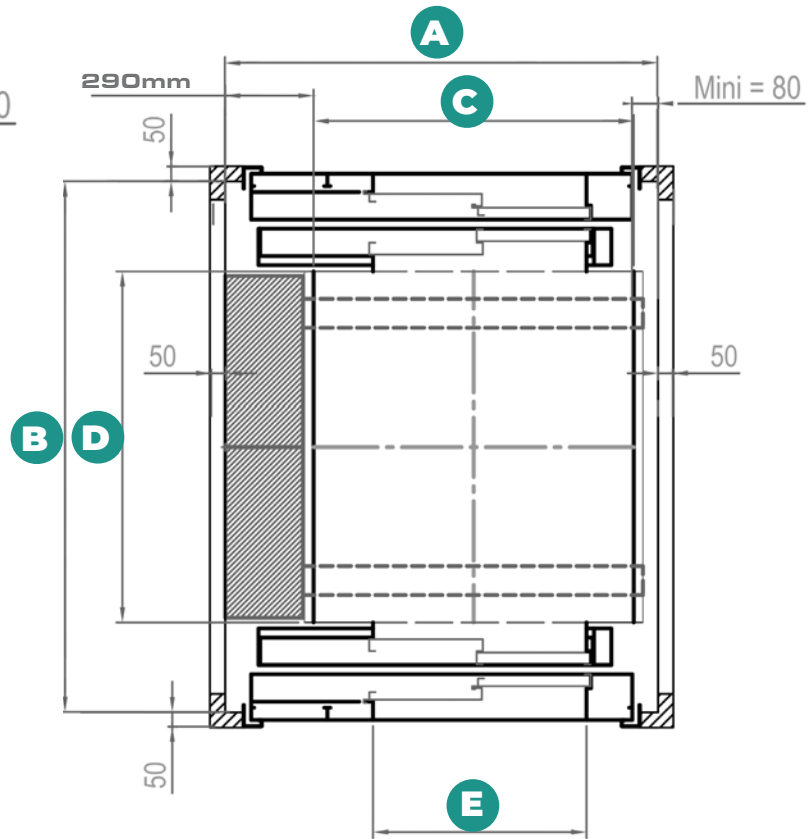
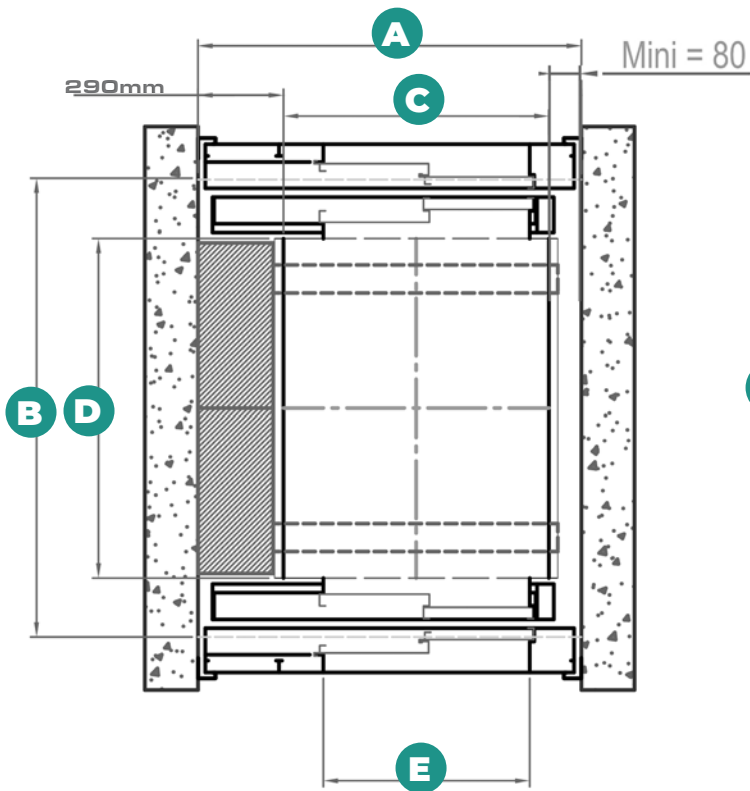

(Dimensions en mm / Size in mm)

		Gaine maçonnerie Masonry sheath		Gaine Pylône Pylon Sheath	
		Mini	Maxi	Mini	Maxi
Vide libre intérieur <i>Interior free space</i>	A	1300	1600	1420	1720
	B	1550	1800	1740	1990
Cabine <i>Car</i>	C	930	1100	895	1100
	D	1150	1400	1150	1400
Passage libre <i>Freeway</i>	E	700	900	700	900



Solution gaine service d'équerre Square service

Mécanique en face B et D
Mechanics in face B and D



Gaine
Sheat

Pylône
Pylon

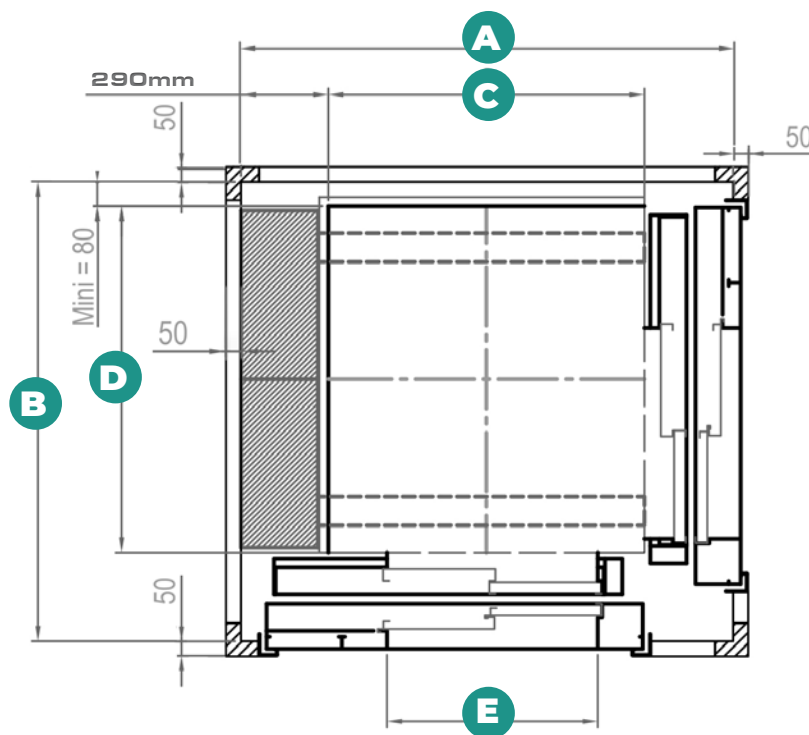
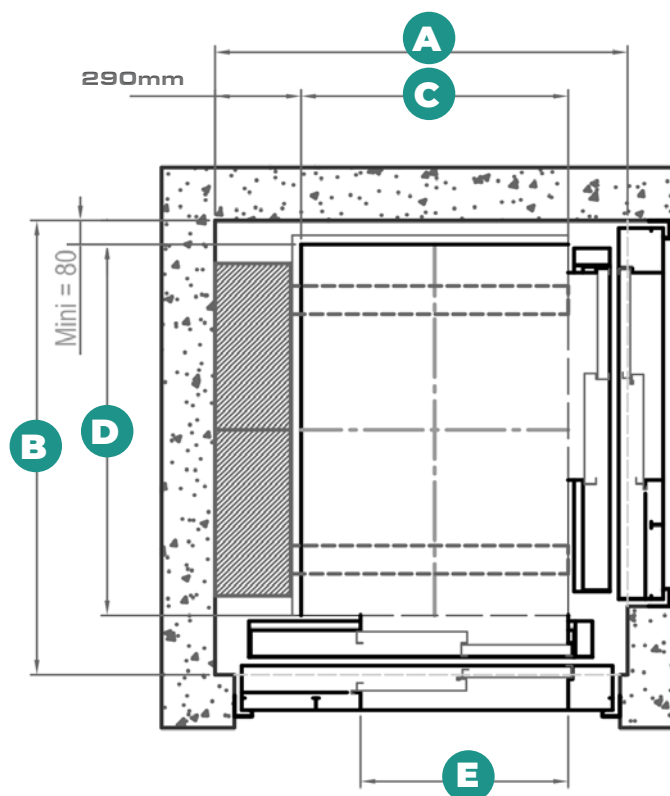

(Dimensions en mm / Size in mm)

		Gaine maçonnée Masonry sheath		Gaine Pylône Pylon Sheath	
		Mini	Maxi	Mini	Maxi
Vide libre intérieur <i>Interior free space</i>	A	1325	1625	1480	1780
	B	1450	1750	1605	1905
Cabine Car	C	835	1100	895	1100
	D	1170	1400	1230	1400
Passage libre Freeway	E	700	900	700	900

Client / Customer :**Numéro client / Number customer :****Référence du projet / Project reference :****Contact / Contact :****Adresse e-mail / E-mail :****Date de la demande / Date of demand :****Type de gaine / Sheath type :**

Maçonnée à construire / Masonry to build
Maçonnée existante / Existing masonry
Pylône fourniture SODIMAS / SODIMAS supply pylon
Pylône lot client / Customer batch pylon

Bâtiment / Building :

Maison individuelle / Dwelling
ERP / ERP
Neuf / New
Existant / Existing
Code du travail / Labor Code

Emplacement / Location :

Intérieur bâtiment
Building interior
Extérieur bâtiment
Building exterior

Dimensions (vide libre intérieur) / Dimensions (interior) :

Largueur (en mm) / Width (in mm)
Profondeur (en mm) / Depth (in mm)
Cuvette (en mm) / Cuvette (in mm)
Hauteur dernier niveau (en mm) / Last level height (in mm)

Configuration / Configuration :

Nombre de niveau / Number of levels
Course (en m) / Stroke (in m)
Motorisation à droite (Mur porteur) / Right-hand drive (Bearing wall)
Motorisation à gauche (Mur porteur) / Left-hand drive Bearing wall

Porte palière battante / Landing door :

(k1) Battante sans oculus CLEA / CLEA Swing without oculus
(k2) Battante sans oculus / Swing without oculus
(k3) Battante avec oculus / Swing with oculus
(k4) Battante grand vitrage / Large glazing hinged
(k7) Avec ouverture automatique / With automatic opening
*Epoxy RAL au choix / *RAL epoxy of choice
De base noir RAL 9005 / Basic black RAL 9005

Ouverture à gauche / left opening
Ouverture à droite / Right opening
Calfeutrement / Caulking

Poignée de porte

Sauf CLEA :
door handle not CLEA :

Boutons paliers :

Landing door button :

(k5) Baton élégance alu / Elegance stick alu
(k6) Baton élégance or / Elegance stick gold
(k8) Cyntra black
(k9) Black pad silver
(k10) Black pad gold

Quantité
Quantité
Quantité

Porte palière télescopique / Telescopic landing door :

Télescopique effacement gauche / Swing without oculus
Télescopique effacement droit / Swing with oculus

(11) Sans facade / Large glazing hinged
(12) Avec facade / With automatic opening
(17) RAL 7032 / RAL 7032
(18) Inox brossé / Brushed stainless steel
(19) Inox lino / Limen stainless steel
(110) Inox gravé / Engraved stainless steel

Calfeutrement / Caulking

Quantité

Boutons paliers :

Landing door button :

Quantité
Quantité
Quantité

(13) Evolya Angel
(14) Evolya Démon
(15) Black pad silver
(16) Black pad gold

PILOTE :

(a1) Oui / Yes
(a1) Non / No

GSM :

Oui / Yes
Non / No

Téléphonie / Telephony :

Oui / Yes
Non / No

Divers / Various :

(o1) Capotage contre-poids
Counterweight cowling
RAL 9005 noir / black
(p4) Eclairage sous plancher
Under floor lighting

Pylône / Pylon :

(m2) Pylône blanc A3000 texture fine / White A3000 pylon fine textured
(m1) *Pylône RAL au choix / *RAL pylon of your choice

Face B=

(p1) Habillage tôle
Laminate base
*RAL extérieur :
*RAL intérieur :
(p2) Habillage tôle déco
Laminate base
*RAL extérieur :
*RAL intérieur :
(p3) Vitrage / Glass

Face C=

(p1) Habillage tôle
Laminate base
*RAL extérieur :
*RAL intérieur :
(p2) Habillage tôle déco
Laminate base
*RAL extérieur :
*RAL intérieur :
(p3) Vitrage / Glass

Face D=

(p1) Habillage tôle
Laminate base
*RAL extérieur :
*RAL intérieur :
(p2) Habillage tôle déco
Laminate base
*RAL extérieur :
*RAL intérieur :
(p3) Vitrage / Glass

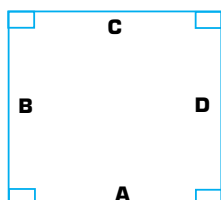

● **Positionnement ensemble mécanique :**

Mechanical assembly positioning :

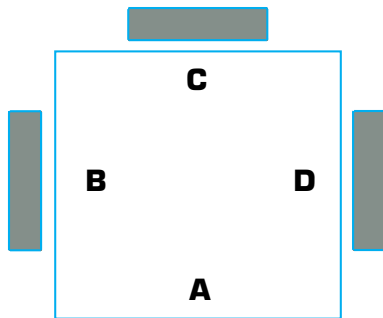
Face B
Face C
Face D● **Passage libre / Freeway :**

600 -> 900 (en mm)

Hauteur / height 2000 mm

● **Face d'accès / Access face :**

Simple / Simple

Opposé (180°) / Opposed (180°)

Service passant / Passing service

Quantité / Quantity

Service d'équerre / Square service

Face B Face D

● **Dimensions cabine / Car dimensions :**

Largueur (en mm) / Width (in mm)

Profondeur (en mm) / Depth (in mm)

● **Finitions parois cabine**

Car wall finish :

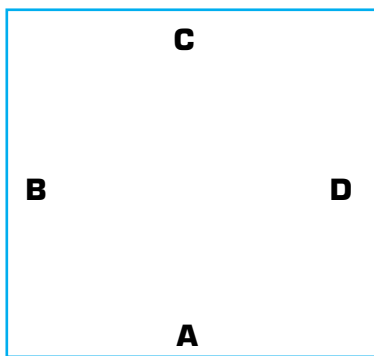
**B=** (f1->f4) Stratifié base
Laminate base

Ref :

(g1->g19) Stratifié ARPA
ARPA laminate

Ref :

(d1) Vitrage
Glass**D=** (f1->f4) Stratifié base
Laminate base

Ref :

(g1->g19) Stratifié ARPA
ARPA laminate

Ref :

(d1) Vitrage
Glass**C=** (f1->f4) Stratifié base
Laminate base
Ref :
(g1->g19) Stratifié ARPA
ARPA laminate
Ref :
(d1) Vitrage
Glass● **Profils d'habillage intérieur cabine**

Cabin interior trim profiles :

(j1) *Epoxy RAL 9005 /*RAL 9005

(j2) *Epoxy au choix dans notre gamme /*RAL range

(j3) Inox brossé / Brushed stainless steel

(j4) Inox lino / Limen stainless steel

(j5) Inox gravé / Engraved stainless steel

(j6) Inox noir brillant / Gloss black stainless steel

*RAL disponible dans notre gamme uniquement / Prélaqué lisse

*RAL available in our range only / Smooth pre-painted

● **Commentaires / Comments :**● **Capotage extérieur cabine (si pylône)**

Exterior cabin trim profiles (if pylon) :

(n2) *RAL au choix /*RAL range

(n1) Inox brossé / Brushed stainless steel

(n3) Inox lino / Limen stainless steel

(n5) Inox gravé / Engraved stainless steel

● **Plafond cabine / Cabin roof :**

(e1) RAL 9003 Blanc / White

(e2) RAL 9005 Noir / Black

(e3) *RAL au choix /*RAL range

(q1) Eclairage cabine par spot Led / Led car lighting

(q2) Eclairage cabine périphérique / Device car lighting

● **Panneau de commande**

Car operating panel :

(i8) Cyntra 4" bouton noir / Cyntra 4" black button

(i9) Evolya 4" Angel

(i10) Evolya 4" Démon

(i1) Afficheur Sensy seul / Sensy display only

Clavier Keypad Sensy :

(i2) Epoxy noir RAL 9005 fine texture / RAL 9005

(i3) Inox brossé / Stainless steel

(i4) Brossé ton OR / Golden hairlined

(i5) Evolya 7" Angel

(i6) Evolya 7" Démon

(i7) Cyntra 7" bouton noir / Cyntra 7" black button

● **Finition panneau de commande**

Car operating panel finish :

(r1) Inox brossé / Brushed stainless steel

(r2) Inox lino / Limen stainless steel

(r3) Inox gravé / Engraved stainless steel

(r4) Inox Or / Golden stainless steel

(r5) *Epoxy au choix /*RAL range

● **Accessoires cabine / Cabin accessories :**

(c1) Miroir / Mirror (H800mm x L450mm)

(b1) Main courante tube alu epoxy noir / Black epoxy handrail

(b2) Main courante lumineuse epoxy noir / Black epoxy handrail

(b3) Main courante lumineuse alu poli brillant / Silver polish

(b4) Main courante lumineuse Or chrome / Golden mirror

● **Sol cabine / Cabin ground :**

(h1) Leone clear 2064

(h2) Azay cream 2346

(h3) Leone anthracite 2133

(h4) Gris stone

(h7) Tarabus

(h8) Sol décaissé / Disbursed soil





Sweet LIFT



03/10/2024



SODIMAS
ascenseurs

11 rue Ampère
26600 Pont de l'Isère
FRANCE

+33(0)4 75 84 86 00
E-mail : accueil@sodimas.fr